

INSTALLATION MANUAL RUUKKI HYYGGE

INSTALLATION MANUAL

RUUKKI

Ruukki® Hygge

Ruukki® Hygge modular steel roof tile is an innovative roofing product that fits perfectly into modern architectural trends thanks to its simple and original form. Ruukki Hygge includes a number of innovative solutions making the roof unique in terms of appearance, as well as functionality and assembly.

The product is available in two versions: with and without grooves. Thanks to such a solution and proper shifting of the panels during assembly, you can obtain three different patterns on the roof and adjust them to your liking.

Single panels have been refined with great care and attention to every detail, and our many years of experience is a guarantee of the highest quality and durability of the roof for many years. Ruukki® Hygge is the perfect solution for people looking for a combination of Scandinavian aesthetics and simplicity with the warmth of your home, or of nature with modernity, i.e. your hygge.

Hygge

This short, inconspicuous Danish word, untranslatable to English, describes everything that really matters in life: a sense of closeness, safety, freedom and warmth. It's a Scandinavian philosophy of happiness, expressing the pursuit of cosy comfort and finding joy in small pleasures.

When you home is hygge...

...It becomes a safe haven in which the whole family meets and gathers strength against the challenges of the outside world, enjoying the sense of community, warm intimacy and everyday rituals. This is a space where children grow up, beloved ones visit, laughter resounds and rests reigns with coffee and candlelight.

A simple, modern, cosy house close to nature – a place you want to come back to. Ruukki® Hygge Simple Form of Happiness was created for such places.

Unique features of Ruukki® Hygge



High quality

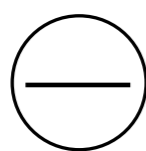

Smooth surface



3 colours

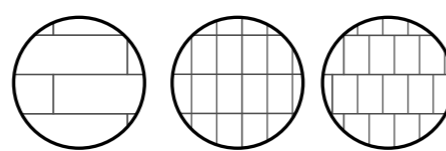

3 patterns

The assembly methods presented in this manual are intended as general instructions. The specific assembly method required may slightly differ from the one described in the manual depending on the type of roof or country of installation. For specific instructions, updates and more assembly tips, please visit our website at www.ruukkiroofs.com. To use the general assembly instructions and tips, follow the instructions of a designer or contact our technical support department.

Content

Ruukki® Hygge	2
Specification	4
Product map	5
Possibility of laying in three patterns	5
Transport and storage, unloading, work safety	6
Correct ventilation of the roof plane	7
Basic flashing and accessories	8
1. System elements version 1	10
2. System elements version 2	10
3. System elements version 3	10
4. Installation of Ruukki H-FIX vapour-permeable membrane	11
5. Patching the roof plane	11
6. Verge trim flashing base	11
7. Installation of rafter-side brackets	12
8. Installation of the ridge batten	12
9. Installation of the verge trim flashing gutter	12
10. Installation of expansion tape	13
11. Positioning the verge trim flashing	13
12. Installation of the verge trim flashing	13
13. Fastening Ruukki® Hygge panels	14
14. Installation of the first row of Ruukki® Hygge panels	14
15. Cutting Ruukki® Hygge panels	14
16. Installation of ridge underside flashing	15
17. Installation of the ridge cap	15
18. Installation of subsequent rows	15
19. Laying a stretcher bond pattern	16
20. Laying a stack bond pattern	16
21. Installation of the bottom eaves flashing	16
22. Installation of the last row of panels	17
23. Positioning the upper eaves flashing	17
24. Installation of the upper eaves flashing	17
25. Installation of the valley gutter	18
26. Sloping ridge	18
27. Window installation	18
28. Installation of the roof window flashing	19
29. Diagram of the layout of panels around the roof window	19
30. Upper flashing of a roof window	19
31. Bottom flashing of a roof window	20
32. Finished roof window	20
33. Extraction fan	20
34. Roof safety	21
35. Chimney flashing	21
36. Installation of chimney flashing	21
37. Rear chimney flashing	22
38. Front chimney flashing	22
39. Ready chimney flashing	22

Specification

Product

Name	Ruukki® Hygge
Total height	26 mm
Total length	343 mm
Effective length	290 mm
Total width	1200 mm
Effective width	1178 mm
Minimum inclination angle	14°
Thickness	0,6 mm
Nominal weight	2,35 kg/szt. 7 kg/m ²
Effective panel area	0,341 m ²
Sale unit	m ²

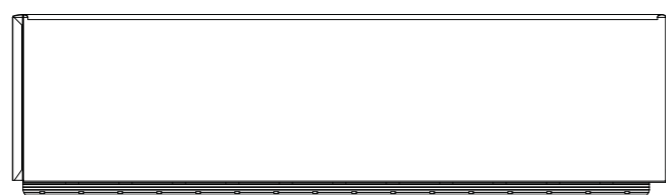
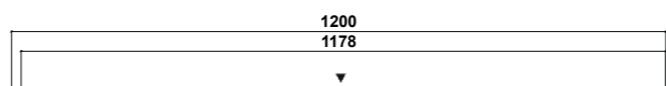
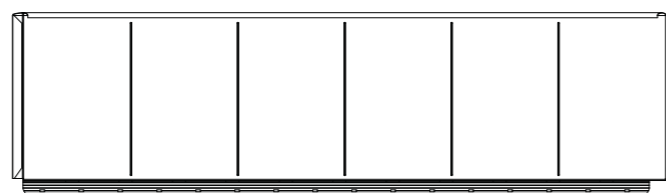
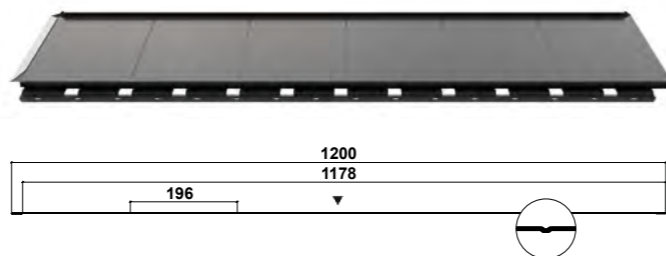

Material

Hot-dip galvanised sheet	PN-EN 10346
Steel-coated flat products	PN-EN 10169+A1

Tolerances

Product	PN-EN 508-1
Material	PN-EN 10143

Colours

Black, Anthracite, Graphite

Material specification

Quality class	Nominal thickness (mm) (PN-EN10143)	Weight (kg/m ²)	Coating	Minimum amount of zinc (g/m ²)
Ruukki 40	0,60	7	GreenCoat Purex	275

Product map

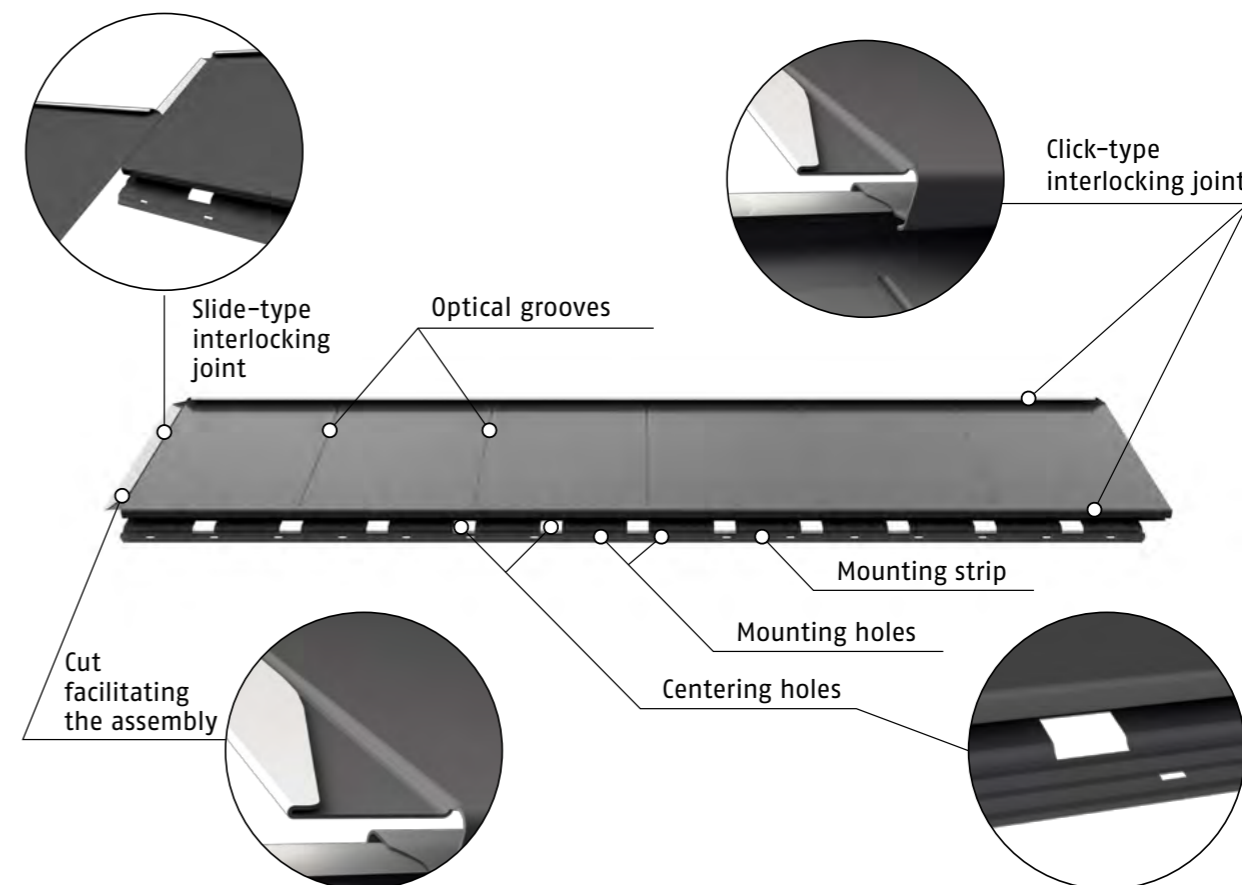

Possibility of laying in three patterns

Ruukki® Hygge without grooves in brick pattern



Ruukki® Hygge with grooves in linear pattern



Ruukki® Hygge with grooves in brick pattern



Transport and storage, unloading, work safety

Receipt of delivery

Make sure that the delivery content matches the order and contains all the goods listed on the shipping list. Any shortages, mistakes or damages occurred during transport should be recorded on the consignment note and immediately reported to Ruukki or the seller. All delivery claims must be reported within 8 days of delivery. Ruukki is not liable for costs incurred as a result of replacing products installed in a manner different from the one described in this manual.

Unloading and moving sheets of tiles

Ruukki Hyygge modular metal roof tiles are delivered in boxes, and the panels are connected in packages of 9 pieces, which can be easily transported to the roof. Unload the boxes on a flat space where you will have easy access to them. When moving individual sheets, make sure that the sheets do not rub against each other. It is best to transfer the sheets to the roof in the factory packages. Calculate the number of sheets needed for the given roof area and place the appropriate number of sheets on it. A hoist can also be used for transporting the tiles to the roof.

Cutting sheets

Roofing sheets are delivered in standard sizes. To cut them you can use a hand-held circular saw suitable for cutting steel, shears, nibbling machine, jigsaw or other non heat-generating cutting tool.

It is strictly forbidden to use an angle grinder and cutting discs to cut tile sheets (cutting with such tools automatically invalidates the product warranty).

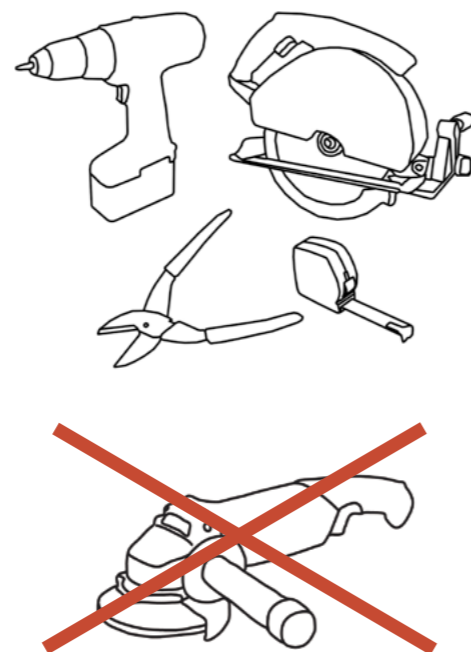
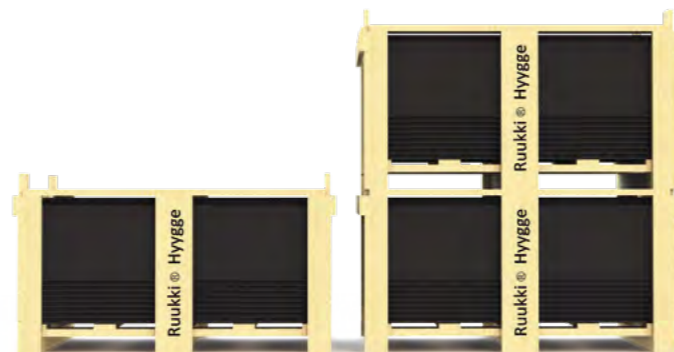

Safety at work

Always wear protective clothing and gloves when working. Avoid contact with sharp edges and corners of the sheets. Avoid working on the roof during strong winds. Be extremely careful when moving around and working on the roof. Use a safety rope, soft sole shoes and comply with all applicable health and safety regulations.

Roof optimisation

Ruukki® Hyygge is available in standard size sheets, so it's relatively easy to calculate the number of sheets you need. When calculating the number of sheets required, remember to add more sheets (about 5%) than the roof surface itself, as there is always a certain amount of waste during assembly. When calculating the amount of flashing needed, remember about lapping and add a suitably larger number.

To make the calculations you will need individual dimensions of each of the roof planes, mainly the length of the ridge line/eaves (W - width of the roof plane) and the top of the roof (L - length of the roof plane). Table 1 shows an example of the calculation.

Correct ventilation of the roof plane

The air void should be made by a suitable installation of the counterbatten subframe - it should have an unobstructed inlet and outlet with a suitable size. Table 2 in a simplified way shows the selection of the height of the air void depending on the length of the roof plane. Remember that the use of meshes, slotted trunking and similar accessories reduces the effective cross-section of the air void, which should be taken into account when choosing the thickness of the counterbatten.

The inlet of the air void should be made in such a way as to ensure a suitable cross-section.

The outlet of the air void in the ridge should have a minimum of 50 cm² per metre on each side of the roof. Special ridge tiles available in our offer have hidden perforations ensuring an adequate degree of ventilation.

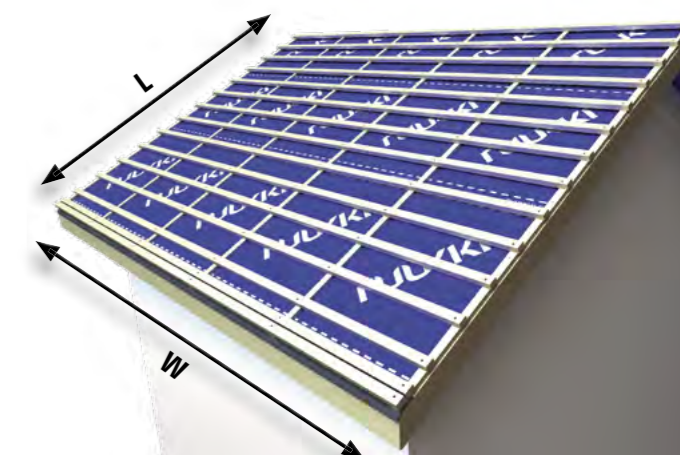

Table 1

Required amount of Ruukki® Hyygge sheets - sample calculation:

L= 8 m

W= 10 m

Area

S = L × W = 8 m × 10 m = **80 m²**

L - length of the roof plane
W - width of the roof plane

Effective number of sheets

S / area of a single sheet

S / 0,34 m² = 80 m² / 0,34 m² ≈ **236 pieces**

Total number of sheets

Effective number of sheets × waste factor

238 × 1,05 ≈ **248 sztuk**

Table 2







Height of the air void according to DIN 4108-03

Rafter length	Cross-section of the air void	Thickness of the counterbatten with allowance
m	cm ² /m	cm
5	200	2,4
10	200	2,4
15	300	3,6
20	400	4,8

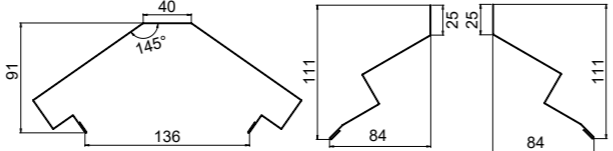
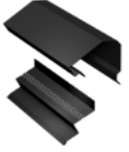
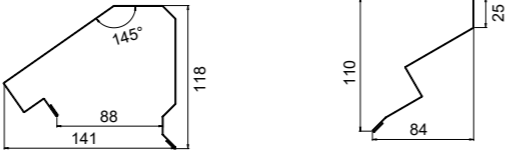
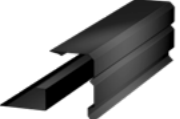
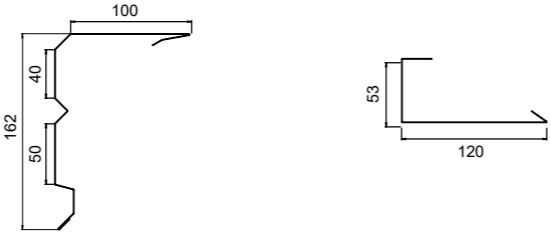

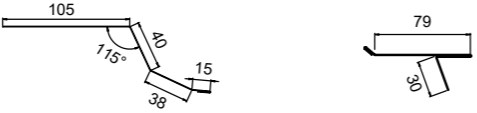

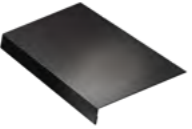







*Allowance includes the cross-section area lost by counterbattens

Basic flashing and accessories

Flashing

Name	Product image	Dimensions	
Ridge cap			
Upper eaves flashing			
Verge trim			
Eaves flashing			
Name	Product image	Name	Product image
Valley flashing		Board flashing, large	
Underlay flashing		Joint flashing	
Board flashing, small			

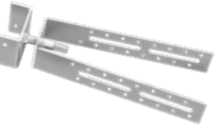
Roof safety

Name	Product image	Name	Product image
Ruukki Hyygge chimney sweep bench Length = 600 mm		Ruukki Hyygge anti-snow barrier Length = 1000 mm	
Ruukki Hyygge chimney sweep bench Length = 2000 mm		Ruukki Hyygge anti-snow barrier Length = 2000 mm	
Name	Product image	Name	Product image
Screws 4.2 x 25 mm, stainless		Insulation tape 15 x 40 mm	
TORX screw (4,8 x 35 mm)		RIDGE TAPE ROLL® FIX 310	
Repair paint		Support for ridge patch + spike Length = 210 mm	
Ventilation fan		Support for ridge patch Length = 202 - 225 mm	
Roof underlay H-Fix			

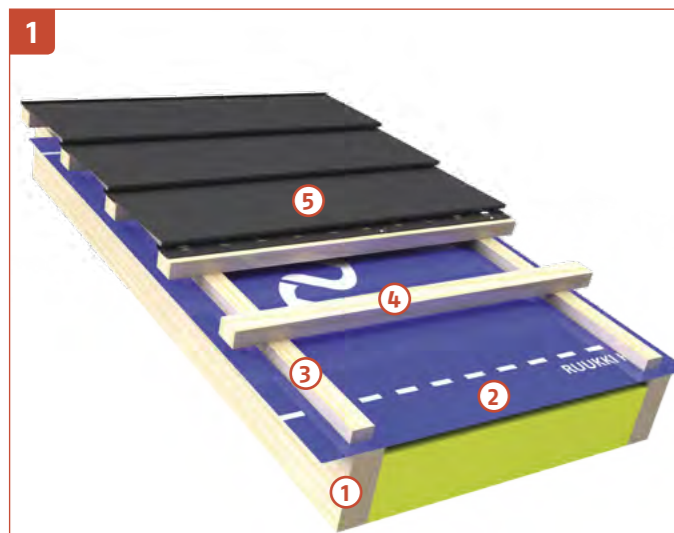

1. System elements version 1

1. Rafter
2. H-Fix roof underlay
3. Wooden counterbatten 25 × 50 mm
4. Wooden roof batten 40 × 50 or 40 × 60 mm
5. Ruukki® Hyygge roof panel

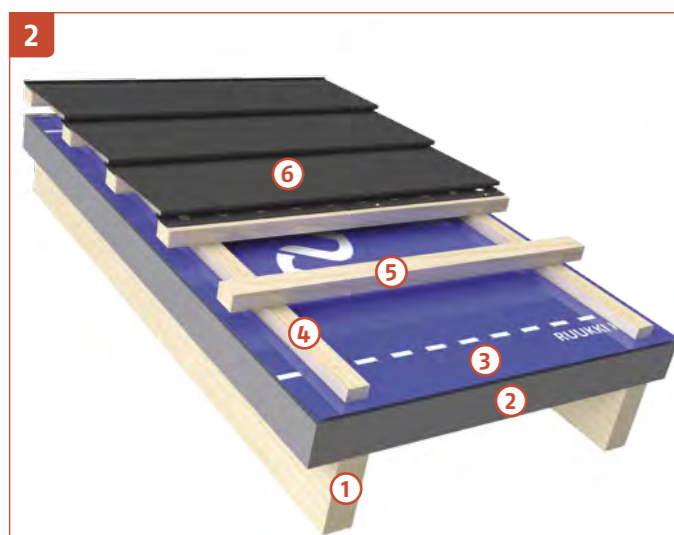

2. System elements version 2

1. Rafter
2. Rafter polyurethane
3. H-Fix roof underlay
4. Wooden counterbatten at least 40 × 50 mm
5. Wooden roof batten 40 × 50 or 40 × 60 mm
6. Ruukki® Hyygge roof panel

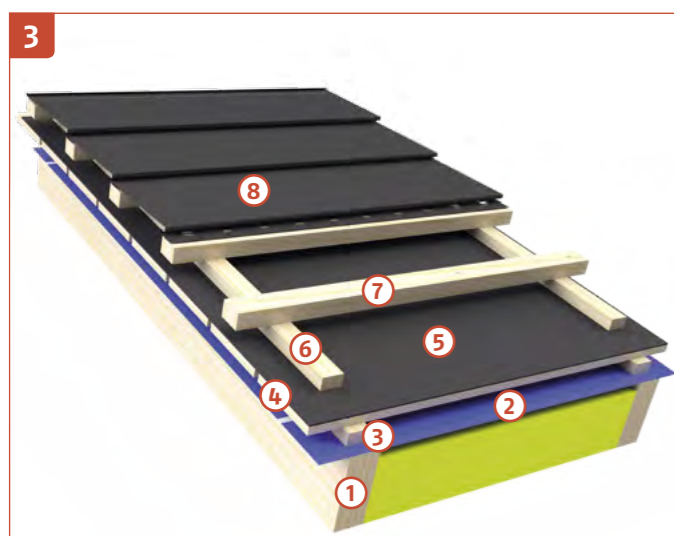

3. System elements version 3

1. Rafter
2. H-Fix roof underlay
3. Wooden counterbatten 25 × 50 mm
4. Full planking at least 25 mm thick
5. Torch-on felt or bituminous membrane
6. Wooden counterbatten 25 × 50 mm
7. Wooden roof batten 40 × 50 or 40 × 60 mm

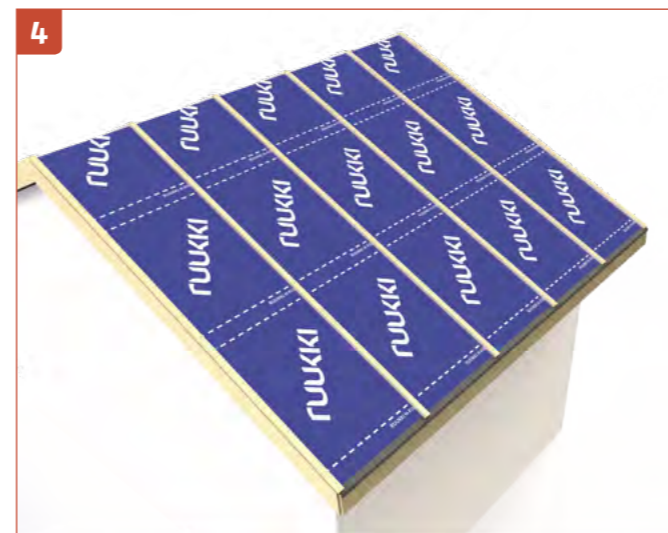

4. Installation of Ruukki H-FIX roof underlay

Start the installation of the roof underlay horizontally from the eaves. It should protrude at least **200 mm** beyond the roof side edges. Fasten the membrane with staples to the rafters and then by screwing in the counter battens, size at least **25 × 50 mm** in accordance with the direction of the rafters. Leave the roof underlay hanging freely between the rafters. Its subsequent strips should overlap by about **150 mm** and be connected using an integrated adhesive strip. Longitudinal connection of the roof underlay is done in the space between the roof rafters with a minimum overlap of **100 mm**.

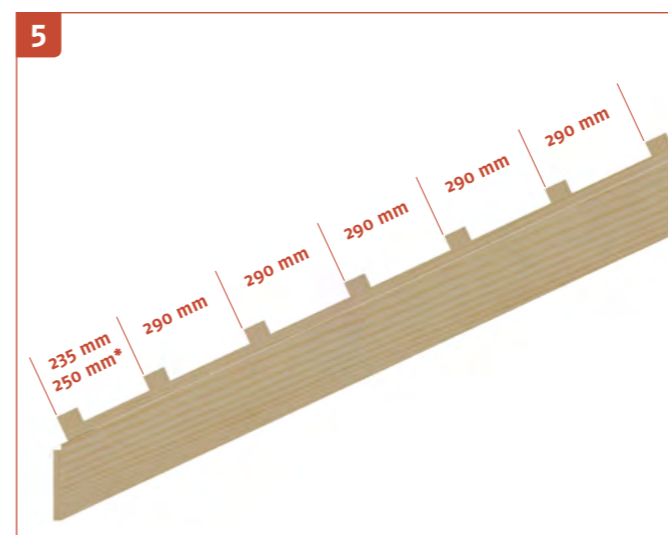

5. Patching the roof plane

For the preparation of the subframe, use wooden battens with dimensions of **40 × 50** or **40 × 60 mm**. The distance between the lower edge of the first batten in the eaves and the lower edge of the second batten should be: **235 mm** using rafter-side gutter brackets or **250 mm** using front gutter brackets. Each subsequent batten must be mounted at a distance of **290 mm** from each other measuring the dimension from the lower edges of the battens. Make sure that the battens are levelled properly and that their foundations are accurate.

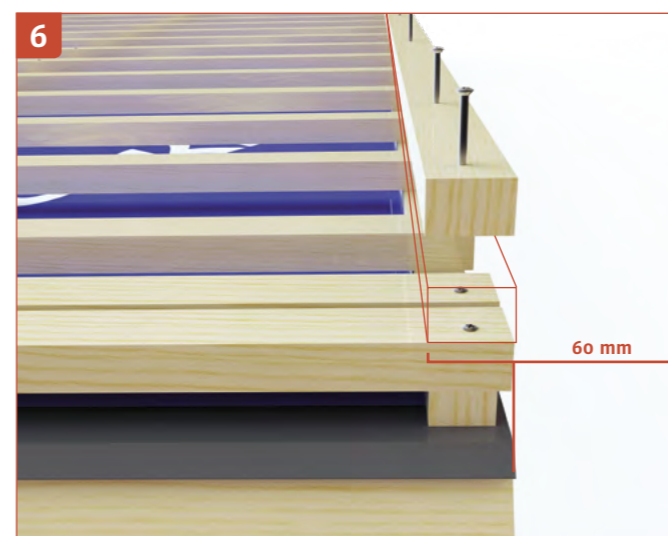

6. Verge trim base

In order to properly install the Ruukki® Hyygge verge trim, place a wooden batten on the edge of the roof.

The inner part of the batten should be located **60 mm** from the edge of the roof. It will be the basis for the installation of a drainage gutter which is also a mounting element for the main verge trim.

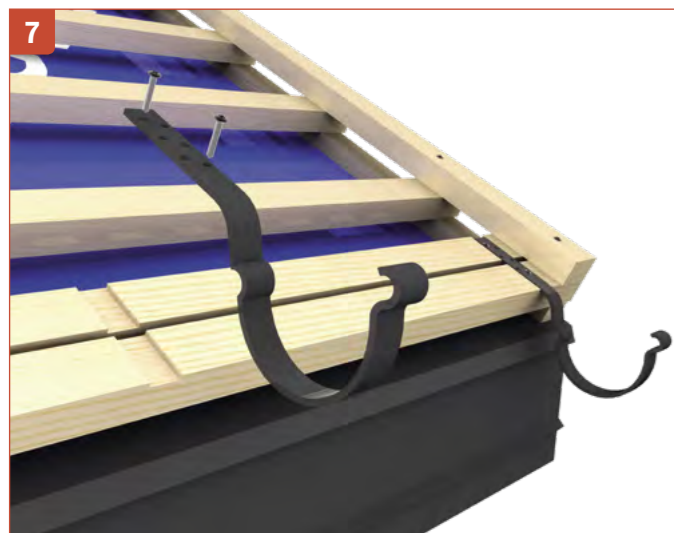

7. Installation of gutter brackets

In order to properly install gutter brackets, install two battens directly adjacent to each other in the eaves, thus providing a solid base for their proper installation. Then chamfer the battens at the place of their foundation so that the mounting element does not protrude above the batten plane. For proper spacing of brackets and selection of the appropriate size of the gutter set, see the installation instructions for the **SIBA** gutter systems.

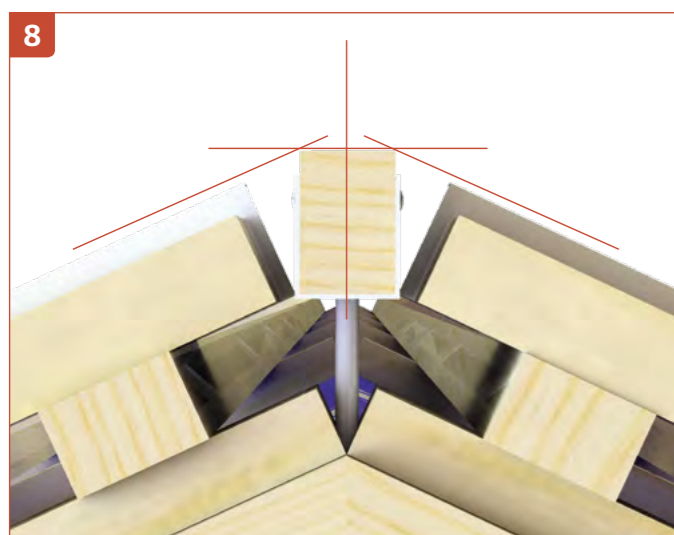

8. Installation of the ridge board bracket

In order to properly mount the ridge cap, a wooden ridge board bracket should be placed in accordance with the axis of the ridge cap at the height of intersection of the upper edges of the verge trim with the upper corners of the ridge bar.

The board bracket will become the base for the installation of the ridge cap parts, masking the cut edges of the sheets and the support of the upper shelf of the main ridge cap. In the case of inter-rafter insulation, use a ridge board bracket with a spike driven directly into the rafter's ridge joint. If the insulation is in the form of a layer on top of the rafter, select the rafter-side ridge bar bracket fitted to the counterbatten.



9. Installation of the verge trim bottom part

To the previously installed batten which is the base of the verge trim, attach the bottom part of verge trim with Torx screws by placing them in the side vertical wall of the flashing as close as possible to the draw element. Such mounting of assembly screws will guarantee the tightness of the element. Remember that the minimum overlap of all parts is **100 mm**.



10. Installation of insulation tape

In order to guarantee optimal tightness, both in terms of protection against rainwater and the risk of blowing loose snow under the roof plane, use a Ruukki insulation tape with target dimensions of **15 × 40 mm** which is a part of the Ruukki® Hygge system. The shape of the tape before expansion will facilitate the assembly of panels and other elements of the system.



11. Positioning the verge trim

Using the draw element of the drain gutter, attach the main verge trim flashing onto it, and then pulling it onto the roof edge, set it in the right position, parallel to the side edge of the roof. Connecting the flashings, trim the bottom elements to aesthetically connect them.

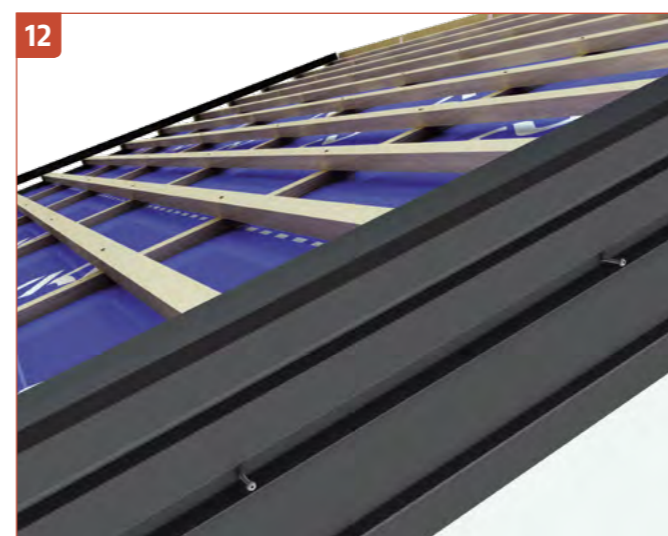

12. Installation of the verge trim

In order to permanently installed the Ruukki® Hygge verge trim flashing system, use Torx screws by placing them in the lower profile of the flashing located on its side outer wall. Such mounting of assembly screws will minimise their visibility, thus improving the aesthetics of the finish.

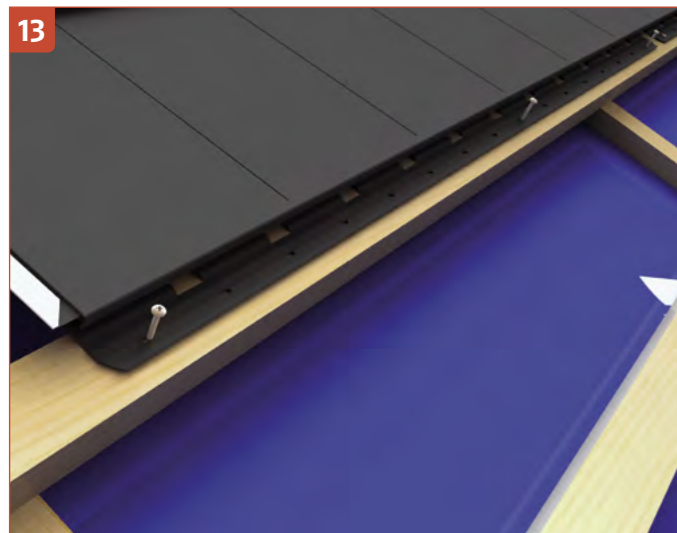

13. Fastening Ruukki® Hyygge panels

To assemble each full panel, use three stainless steel flat head screws, placing them in the middle and two outer mounting holes in the strip. Place the panels so that the edge of the mounting strip is **25 mm** from the lower bottom edge of the mounting strips.

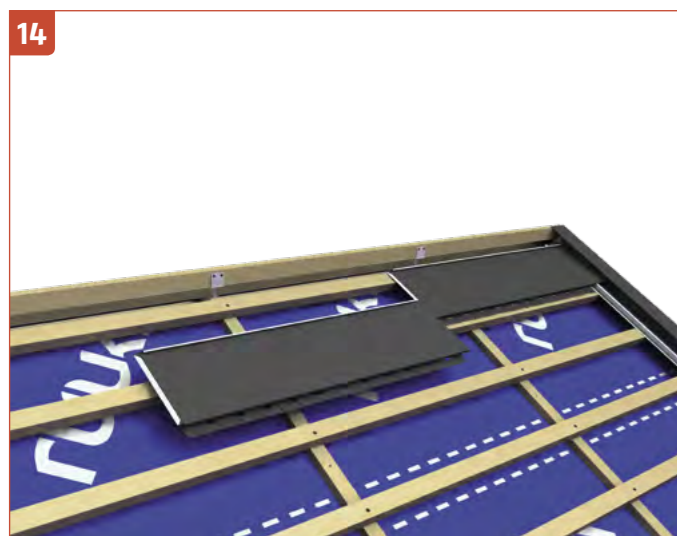

14. Installation of the first row of Ruukki® Hyygge panels

After carefully marking (measuring) the roof, install Ruukki® Hyygge roof panels starting from the upper right side of the roof plane. Edge panels located nearby verge trim flashings on both sides of the roof plane should be prepared in accordance with the guidelines included in **Section 15**. Each subsequent panel is fastened with the previously installed one using the slide type interlocking joint. If necessary, the first row of panels should be cut to provide proper ventilation of the roof partition within the ridge. **Remember that the first row and its careful assembly will affect the final effect of the entire roof.**

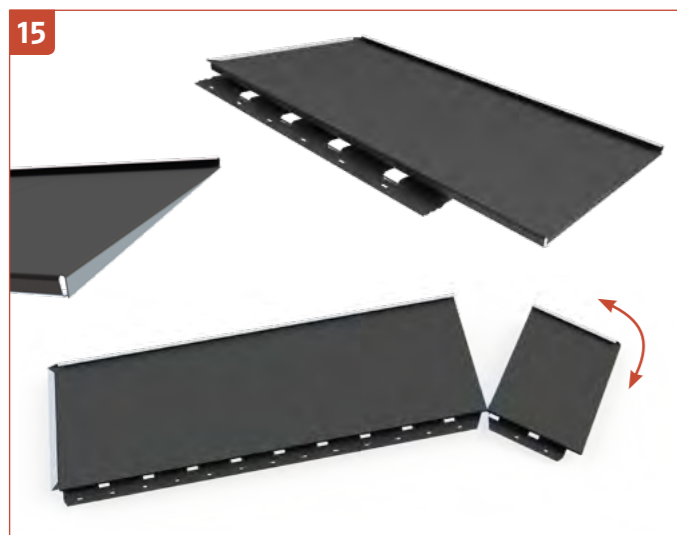

15. Cutting Ruukki® Hyygge panels

Cut the tube of the male click interlocking joint avoiding its deformation and then the flat part of the sheet.

Cut the mounting strip together with the female click interlocking joint, and divide its vertical (step) edge with several movements without using the shears.

Bend the cut edge downwards at an angle of **90°** along the entire length of the sheet, making sure that the bend closing the panel does not hinder its assembly. For this purpose, the bending dimension should be **15 mm** in the front of the panel and go down to **0 mm** in its rear part.

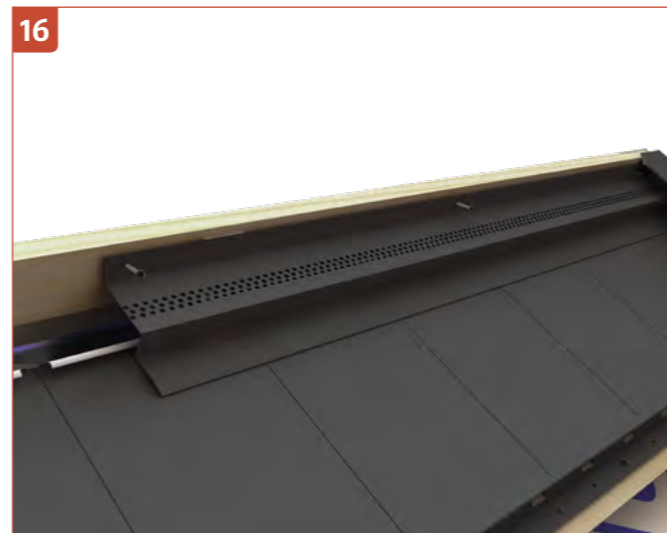

16. Installation of ridge bottom parts

In order to guarantee the highest aesthetics of the roof after installing the first rows of Ruukki® Hyygge panels on two opposite roof planes, start the assembly of the ridge cap system. Thanks to this, you will avoid later return to this element and walk on finished parts of the roof. The assembly of the ridge flashing begins with the installation of the ridge bottom parts to the side edges of the ridge battens on its both sides. For its assembly, use stainless screws with a flat head.

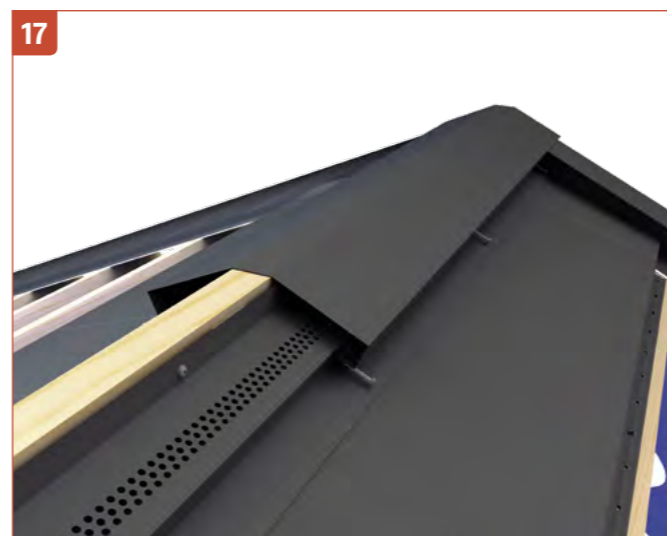

17. Installation of the ridge cap

Place the main ridge cap on the pre-assembled elements and tighten it with Torx screws to the vertical wall of the ridge underside flashing located just below the ventilation part. Such mounting of assembly screws will minimise their visibility, thus improving the aesthetics of the finish.

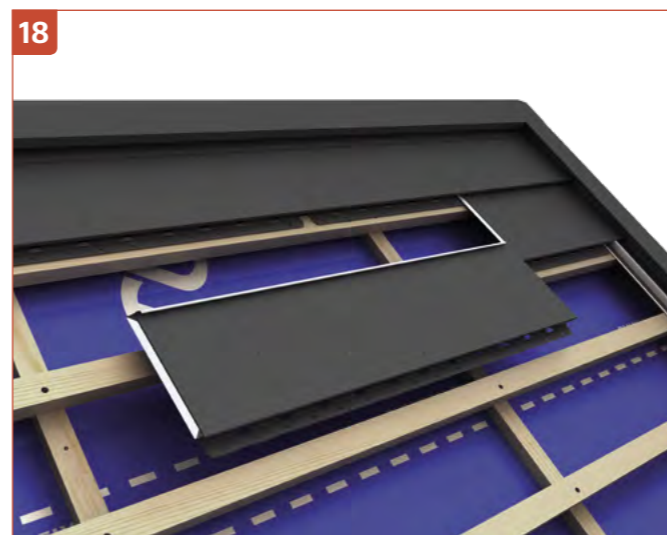

18. Installation of subsequent rows

Cut the first panel of the second row in half. The final dimension of the element is determined by the pattern chosen by the owner and the need to assemble the panels with the shift of the slide-type side interlocking joints. Insert the prepared panel into the horizontal click interlocking joint. Attach the panel to the batten with the screws. Insert the next panels into the slide side interlocking joint until they are attached into the click horizontal interlocking joint. The connection of subsequent panels in both planes in accordance with the above guarantees that their position will be correct. Repeat the process by starting successive rows alternatively starting with the whole or cut panel until the roof plane is finished.



19. Laying a brick pattern

In order to obtain the correct brick pattern, set each subsequent row of panels so that the side slide interlocking joints are located in the centring holes between grooves in the higher row of panels.

Remember to attach subsequent rows of panels with the offset as close as possible to the middle of the previous row of panels so that the rainwater flows out of the side slide interlocking joint to the next full panel!



20. Laying a linear pattern

In order to obtain the correct linear pattern, set each subsequent row of panels so that the side slide interlocking joints are located in the centring holes on the line of grooves in the higher row of panels.

Remember to attach subsequent rows of panels with the offset as close as possible to the middle of the previous row of panels so that the rainwater flows out of the side slide interlocking joint to the next full panel!



21. Installation of the bottom eaves flashing

Before installing the last row of Ruukki® Hyygge panels, the bottom flashing of the eaves should be set and installed. Set it at a distance of **345 mm** (counting from the centre of the click interlocking joint of the row next to the last row of panels) and screw it with stainless screws with a flat head to the first batten.



22. Installation of the last row of panels

After installing the bottom part of eaves flashing, the roof can be closed by installing the last row of Ruukki® Hyygge roof panels.

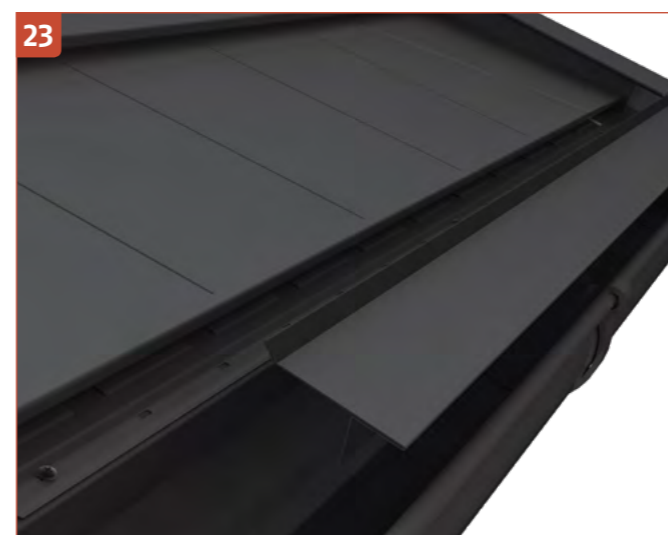

23. Positioning the upper eaves flashing

In order to obtain tightness and aesthetics, the bent edge of the flashing should be placed in the click interlock joint of the last row of panels, and then its vertical edge fitted to the vertical edge of the bottom flashing. Both edges should be in the same position.

Cut the side edges of the upper eaves flashing and slide them under the barge verge trim.

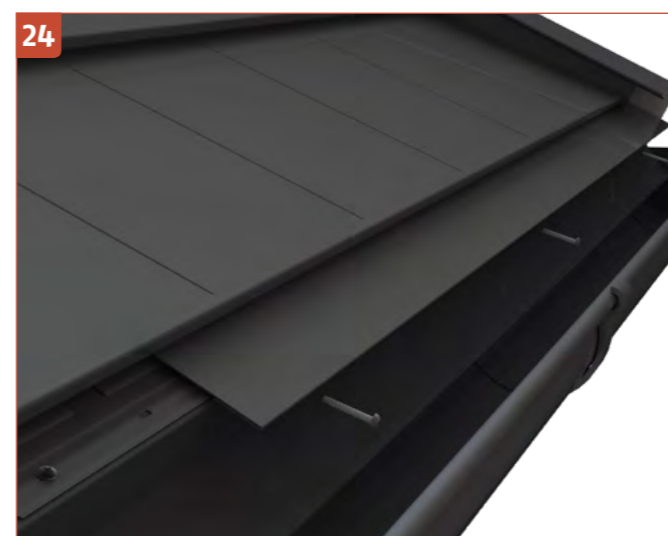

24. Installation of the upper eaves flashing

In order to ensure the durability of the eaves, the vertical edges of the upper and bottom flashing should be connected together by means of torx screws. This solution will ensure both tightness and a high level of aesthetics by covering the screws under the eaves.

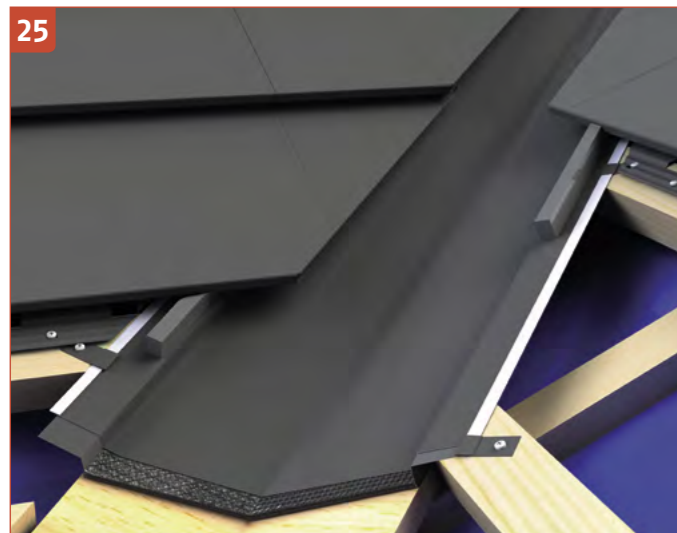

25. Installation of the valley gutter

In order to properly install the valley gutter, construct the valley base from a OSB board or board with a thickness of up to **20 mm** and an arm width of **140 mm** from the valley axis. Place a structural membrane, for example **Plannja Expert**, at the bottom of the base. Then install the Ruukki® Hyygge valley gutter system using mounting brackets. Near the valley gutter edges place the insulation tape in order to better secure its tightness. Prepare the Ruukki® Hyygge panels in accordance with the guidelines set out in **Section 15** cutting them diagonally according to the valley axis and assemble them, leaving **180 mm** gaps between the sheets in the rows of opposite planes.



26. Sloping ridge

Install a ridge patch **90 mm** above the level of contact of the opposite planes. Apply Ruukki RIDGE TAPE ROLL® FIX by carefully gluing it on the spacing, joints of individual sheets. Next, install the ridge underside flashing the side of the ridge board so that its edges adhere to the sheet spacing. Cover the whole with the main ridge cap and fasten it with Torx screws to the vertical wall of the ridge underside flashing located just below the ventilation part. Such mounting of assembly screws will minimise their visibility, thus improving the aesthetics of the finish.

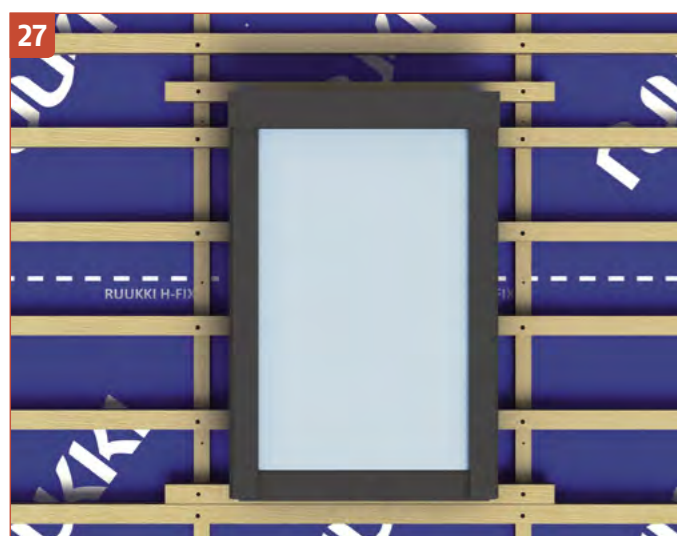

27. Window installation

Install the roof window in accordance with the manufacturer's recommendations by making an additional batten that forms the base on the window frame. The window should be placed **60 mm** above the battens constituting the sub-frame for the Ruukki® Hyygge roof panels.

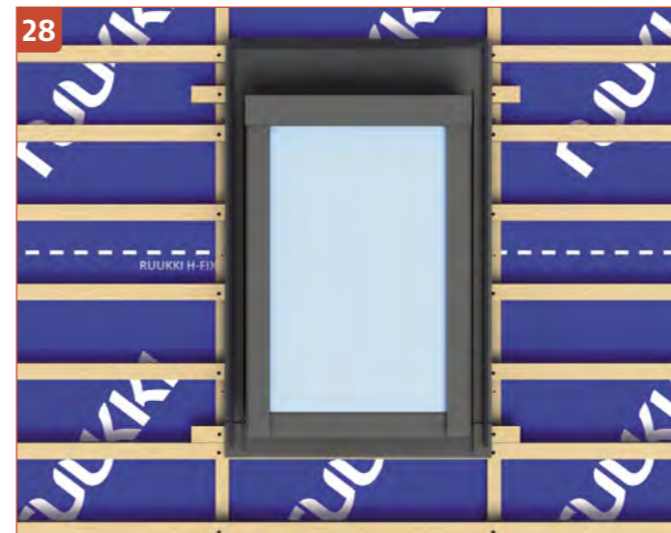

28. Installation of the roof window flashing

Install the roof window flashing according to the window manufacturer's instructions. Fill the collar with Ruukki® Hyygge's expansion tape on the edges of the back and side flashing elements to improve its leak tightness. For the installation of windows use flashing designed for flat roof planes offered by all the leading manufacturers of roof windows.

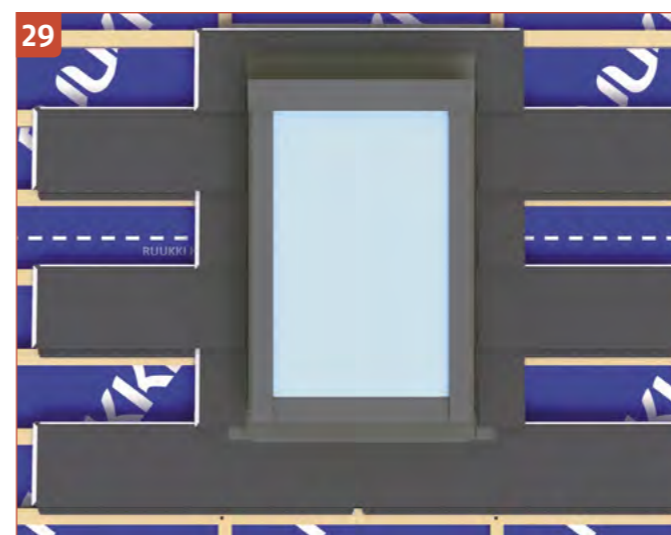

29. Diagram of the layout of panels around the roof window

The panels in the vicinity of the roof window should be installed in accordance with the diagram resulting from the general arrangement of joints, thanks to which you will avoid problems associated with fitting the next rows of sheets behind the window. The sheets adjacent directly to the sides of the window frame should be cut in accordance with the guidelines included in **Section 15**.



30. Upper flashing of a roof window

Depending on the position of the window relative to the arrangement of panel joints, prepare one or two adjacent panels so that the upper, cut edge of the prefabricated panels is about **100 mm** from the top edge of the window, and the lateral edges reach the angle brace of the window's side flashing. All the cut edges should be bent downwards at a **90°** angle so that the bend closes the spaces created at the cutting point.

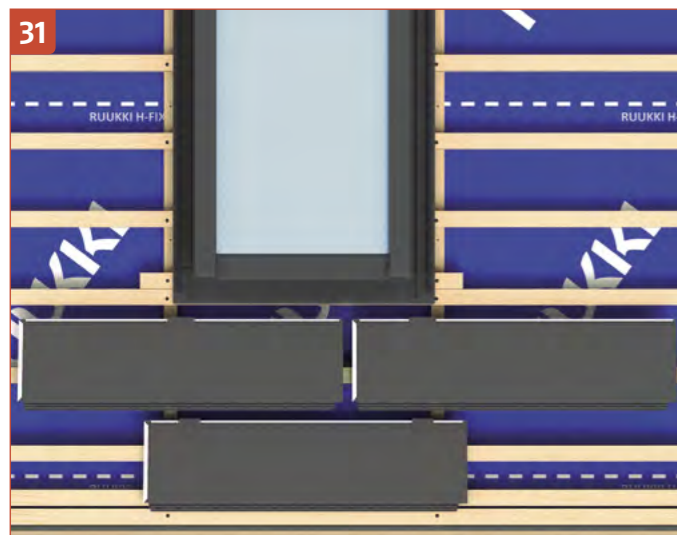

31. Bottom flashing of a roof window

Depending on the position of the window relative to the layout of the panel joints, prepare one or two adjacent panels by cutting out a fragment of the pipe which forms a part of the click-type interlocking joint. This undercut allows collision-free insertion of panels under the side flashing of the roof window. The width of the undercut should be adjusted to the width of the side flashing characteristic of the roof window flashing from individual manufacturers.

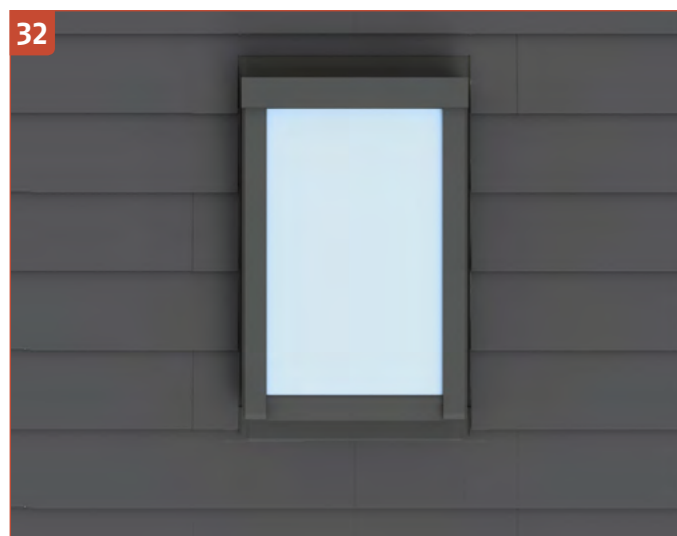

32. Finished roof window

At the end, paint the bend of the side flashing that reveals the undercoat varnish using the Ruukki patch paint in the colour of the roofing. The window with flashing constructed in this way achieves the guarantee of tightness declared by the manufacturer. The technical solutions of Ruukki® Hyygge panels also allow the installation of roof windows in a lowered position with the use of window thermal insulation accessories, thanks to which you can significantly improve the thermal insulation coefficient of a roof window.



33. Ventilation fan

Cut a hole in the panel with a cross-section of **200 mm** taking into account the change in the shape of the hole resulting from the angle of the roof plane. Align the base of the fan to the panel in such a way that it fits over the entire surface, and its upper bent edge is located in the back part of the click-type interlocking joint. The front edge of the base should be firmly connected to the stepped edge of the panel by means of tight stainless rivets. Attach the stack pipe reducer to the base, and then the spiral duct.

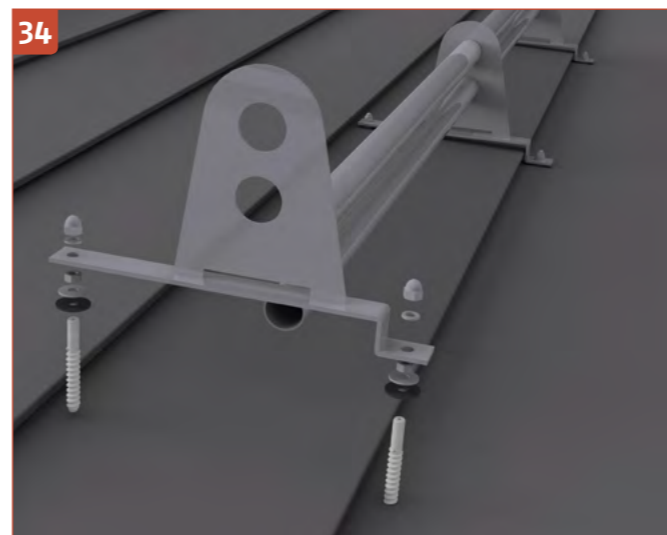

34. Roof safety

To assemble roof safety accessories, use only connectors included in the set. Use a drill, make holes in the Ruukki® Hyygge panel with a diameter of 10 mm just after the step of the wave. Through the holes made, screw a double-threaded screw into the batten so that its top protrudes from 25 to 30 mm above the panel. Place a sealing washer followed by a steel washer and press both against the top of the panel with a nut so that it does not deform its flat part. Then install the base suitable for the given accessories by using a steel washer and a pan-head cap.

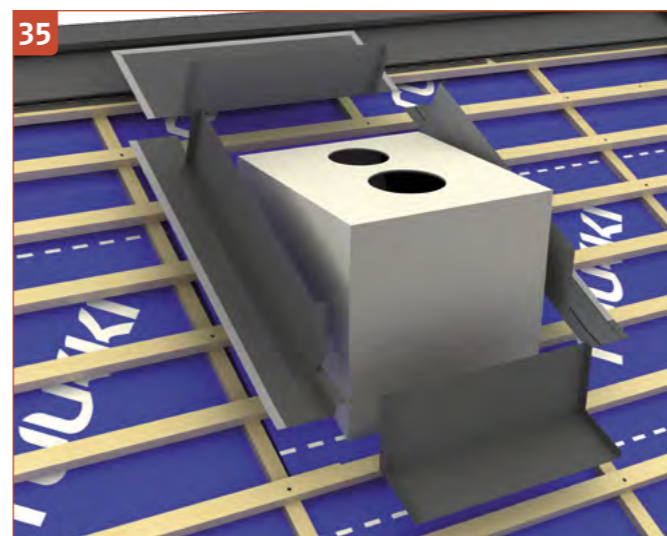

35. Chimney flashing

Install chimney flashing with a height of vertical walls of 150 mm. The dimension of the rear flashing is: **400 mm (effective depth) × (chimney width) + 300 mm**. The dimension of the side gutter base is **160 mm** in width. The edges of the side flashing and the rear flashing should be bent inwards so as to limit the transfer of condensation to the membrane. The front flashing should be **from 150 to 350 mm (depth) × (chimney width)**. The final depth will be determined by the foundation of the chimney with respect to the battens. In all flashing, take into account the elements necessary to connect them with a seam.

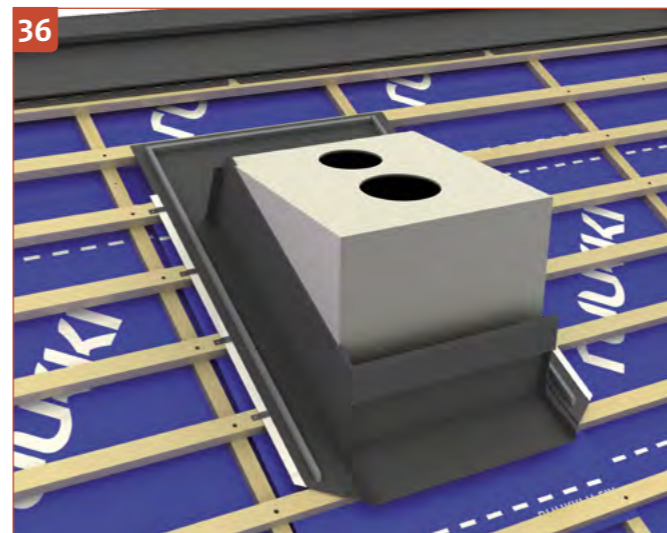

36. Installation of chimney flashing

Install the prepared chimney flashing using brackets for wooden battens and connect with a seam. In order to guarantee optimal tightness, both in terms of protection against rainwater and the risk of blowing loose snow under the roof plane, on the edges of the rear flashing and the side gutters, use a Ruukki expansion tape with target dimensions of **15 × 40 mm** which is a part of the Ruukki® Hyygge system.

The information given in this catalogue is carefully checked. Ruukki Corporation is not responsible for errors, omissions and for any indirect or direct damage caused by incorrect use of information. Ruukki Corporation reserves the right to change the dimensions, colours, type or appearance of the elements presented in this catalogue.

RUUKKI

Ruukki Construction Oy, Jonkankatu 4, P.O. Box 677, FI-20361 Turku, Finland, Tel. +358 (0) 20 59 127, www.ruukkiroofs.com

Copyright© 2018 Rautaruukki Corporation. All rights reserved. Ruukki, Rautaruukki, Bulding your tomorrow, and Ruukki's product names are trademarks or registered trademarks of Rautaruukki Corporation, the subsidiary of SSAB.